

Document Camera

User Manual

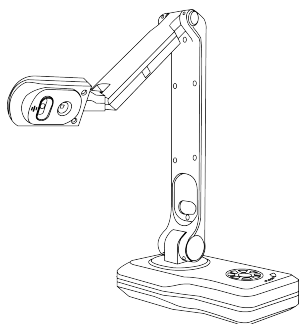

Attentions

Before use:

- It is advised to use the provided power adapter in the package with this product.
- Do not leave it under direct sunlight or by heaters. It may be discolored or damaged.
- Do not place this product in any humid, dusty, or vibrating locations.
- Carry the product by holding the base in both hands. Never hold the product by the arm or the camera head.
- Use a soft, dry cloth for cleaning instead of any volatile solvent.
- When the device is not in use for a while, please turn off the power
- Fold the arm when the product will not be used for long time.

During use:

- Please prevent children from operating the device without supervision.
- Recommended environmental conditions: Temperature: 0°C - 40°C (32°F - 104°F).
- Humidity: 30% - 85% (No condensation).
- Use the product on a stable base, desk, or table.
- Do not turn or flip the camera head or arm to its limitation as below manual instructs.
- Do not point the camera lens directly at the sun. It may be damaged and fails to take pictures.
- Do not look directly to the LED lamps to prevent your eyes from being damaged.
- The product may not be operated properly if a USB hub is used to connect the product and a PC.
- Transfer the data from the SD card onto a device such as a PC to save a backup copy. Malfunction of the product or repairs may cause the data in the SD card to be deleted.
- Be careful to prevent the unit from dropping or overturning.
- Please prevent the camera head to hit the desk top or any other hard objects, or it can be damaged easily.

Packing List

1.Document Camera



5.Remote Controller



2.USB2.0 Cable



6.CD



3.HDMI Cable

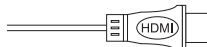

7. VGA Cable

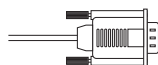

4.DC Adapter (Output:12V1A)

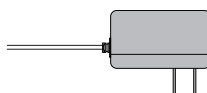

8.User Manual



Product Highlights

- 8.0 Mega Pixel 1/4" CMOS(3264 × 2448).
- Image capture and processing, Audio & Video Recording.
- Auto Focus & 100x Digital Zoom Function.
- Flexible Camera Head with 270° rotation.
- Picture-in-Picture (PIP) Mode.
- Connect directly to Projector / monitor
- 5 level dimmable LED brightness control.
- Built-in Microphone.
- Remote control included.
- Annotate directly without PC software installation and save into SD card.
- Support touch function when connected with Touch screen.

Image roam

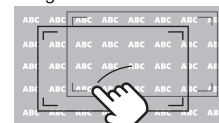
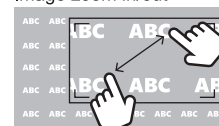
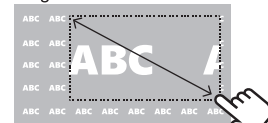

Image zoom in/out



Magnifier



Product Preview

Parts identification

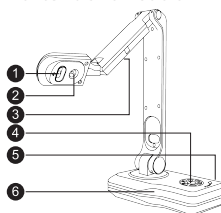

- 1-Camera Lens
- 2-LED Light
- 3-LED Lights
- 4-Control Buttons
- 5-Interface Ports
- 6-Base

Side panel port illustration

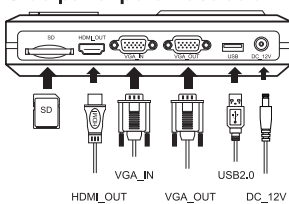

Product Preparation

Setting up

- 1.Lift up camera arm vertically.

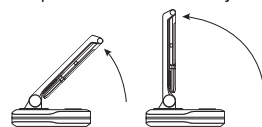

- 2.Rotate the arm 180° to the reverse side.

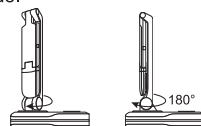

- 3.Lift up the camera head to be horizontal with the panel.

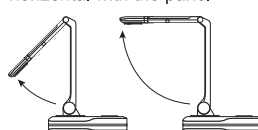

Camera moving parts illustration

- 1.Camera arm 180° rotates.

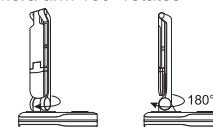

- 2.Camera arm 135° flips.

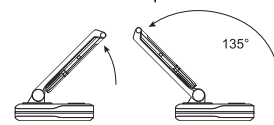

- 3.Camera head 270° rotates + 135° flips.

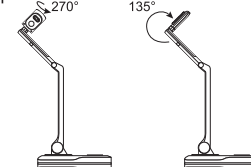

Operating panel illustration

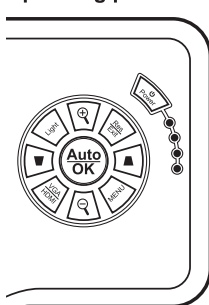

- ▶ Turn on the power
- ▶ Zoom in current image
- ▶ Zoom out current image
- ▶ Function selection
- ▶ Function selection
- ▶ Turn on/off and adjust the LED lights
- ▶ Press to realize the function/auto focus
- ▶ Change the resolution/back to main menu
- ▶ Change to VGA/HDMI
- ▶ Go to the main menu

PC Connection

- 1.Plug in the power adapter to the power socket and Document Camera.
- 2.Connect the USB cable to the PC and Document Camera.
- 3.Install the software.

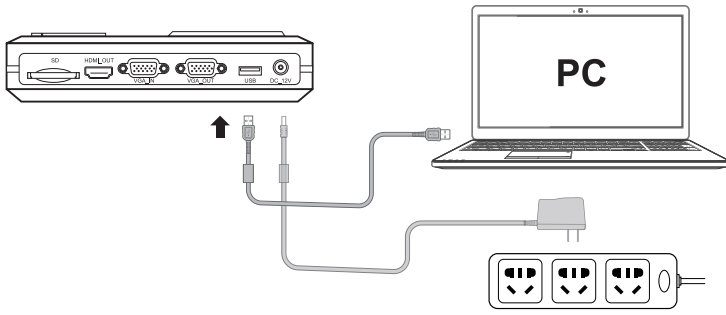

PC-Less

- 1.Plug in the power adapter to power socket and Document Camera.
- 2.Connect the HDMI/VGA cable to the Document Camera and Touch screen.
- 3.Connect the USB cable to the Document Camera and Touch screen (touch usb port).

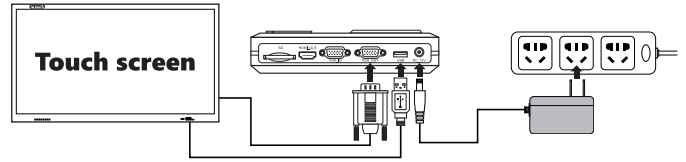

*Calibration need to be done first for the touch function after connection.

Document Camera and external equipment connections as below:

Document Camera Interface	Connection Cable	External Equipment Interface
HDMI_OUT	HDMI	HDMI_IN
VGA_OUT	VGA	VGA_IN
VGA_IN	VGA	VGA_OUT

Menu in HDMI/VGA Display



- Automatic Focusing.
- Magnify the selected area.
- Zoom in the image.
- Zoom out the image.
- Rotate image by 90°/180°/270°/360°.
- Mirror the current image.
- Freeze the image.
- Contrast captured image with live image.
- Capture a still image.
- Record a video clip.
- Browse images and videos in SD card.
- Display captured images with live image on right top window.
- Annotate on the screen and the annotation can be saved into SD card.
- Camera settings and other settings.

Image Shooting & Video Record

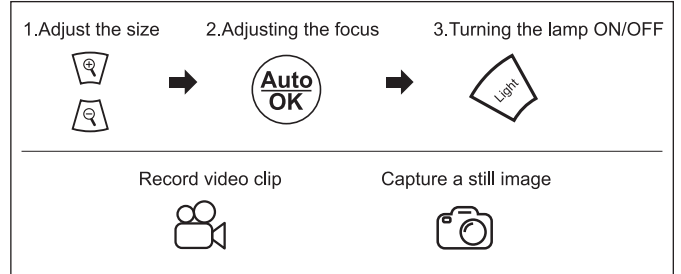

Using the SD card

- 1.Insert the SD card into the SD card slot of the rear panel.

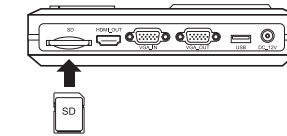

- 2.When SD card is inserted successfully, capture images will be saved automatically to SD card.
- 3.Push the SD card slightly with your finger, the SD card can be removed.

Trouble Shooting

Problems	Possible causes	Solutions
The device does not turn on in normal condition.	The USB cable is not well connected with power.	Reconnect the USB cable.
	The power adapter is not well connected to the device or the power socket.	Make sure the power adapter is connected correctly to the device and power socket.
No image display after device connection.	The power is not turned on.	Turn on the power.
	The device is not connected to the external equipment correctly.	Re-connect the device with the external equipment.
	The external equipment is not selected correctly.	Select the correct external equipment.
	The device is not switched to the correct source of signals.	Switch to the correct source of signals.
The device fails to capture images or record videos.	Equipment resolution not right.	Select the right resolution from equipment or Document Camera.
	SD card memory is insufficient.	Remove some files and clear up the memory space of SD.
The image is blurry.	The object is too close to the camera head.	Use Auto Focus or Manual Focus to adjust the focus.
The image is too dark.	The intensity of the lighting is insufficient.	Turn on the LED light and press the light button on the operating panel to adjust the brightness.
The image does not move.	Image Freeze function is activated.	Press again the Freeze function key on the control panel or the remote control to close the function.
The remote control does not respond.	The battery runs out.	Please replace with new batteries.
	The distance between the remote control and the device is too far.	Please shorten the distance between the remote control and the device.
Touch does not respond on Touch screen.	USB cable not well connected.	Reconnect the USB cable
	No calibration process after connection.	Do the calibration

Specifications

Pickup Device	CMOS 1/4", 8 MP
Resolution	3264*2448(8MP) 2592*1994(5MP) 1920*1080(1080p) 1280*960(SXGA) 1280*720 (720p)
Frame Rate	15fps@1920*1080
Zoom	100 X digital zoom
AF/AE/AW	YES
Shooting Size	< A3
Color Display	Color/Black &White/Negative
Image Processing	Contrast ratio, Brightness control, Sharpness, Saturation, Edge enhancement, Digital denoise, Freeze, Split, Picture-in-picture, Mirror, Image rotation, Annotation, USB control
Interface Ports	USB 2.0, HDMI OUT, VGA IN,VGA OUT,SD(SD2.0, 32G)
HDMI &VGA	2592*1994@60HZ 1280*960@60HZ 1280*720@60HZ 1920*1080@60HZ
Photograph (Analog)	JPEG, 1080P, 5M
Video	720P/25, 1080/5(AVI)
Photograph (USB)	1080P, 5M
UAC	UAC, WIN,MAC YUV 2fps@3264*2448 YUV 2fps@2592*1994 YUV 5fps@1920*1080P MJPEG 15fps@1920*1080 YUV 12.5fps@1280*720 MJPEG 15fps@1280*720 YUV 15fps@800*600 MJPEG 15fps@800*600
DC Power	EA 12V 1A
Built-in MIC	MIC/12S Coder(12S in HDMI)
Control Panel button	Zoom in, Zoom out, Function Selection, Auto Focus/OK, Light, Menu, VGA/HDMI, Resolution/Exit,Power
Size	Folded: 310mm*110mm*70.5mm Open: 185mm*262.5mm*317.5mm
Weight	1.1kg